

YENİ NESİL
KORKULUK SİSTEMLERİ

NEXT GENERATION
RAILING SYSTEMS

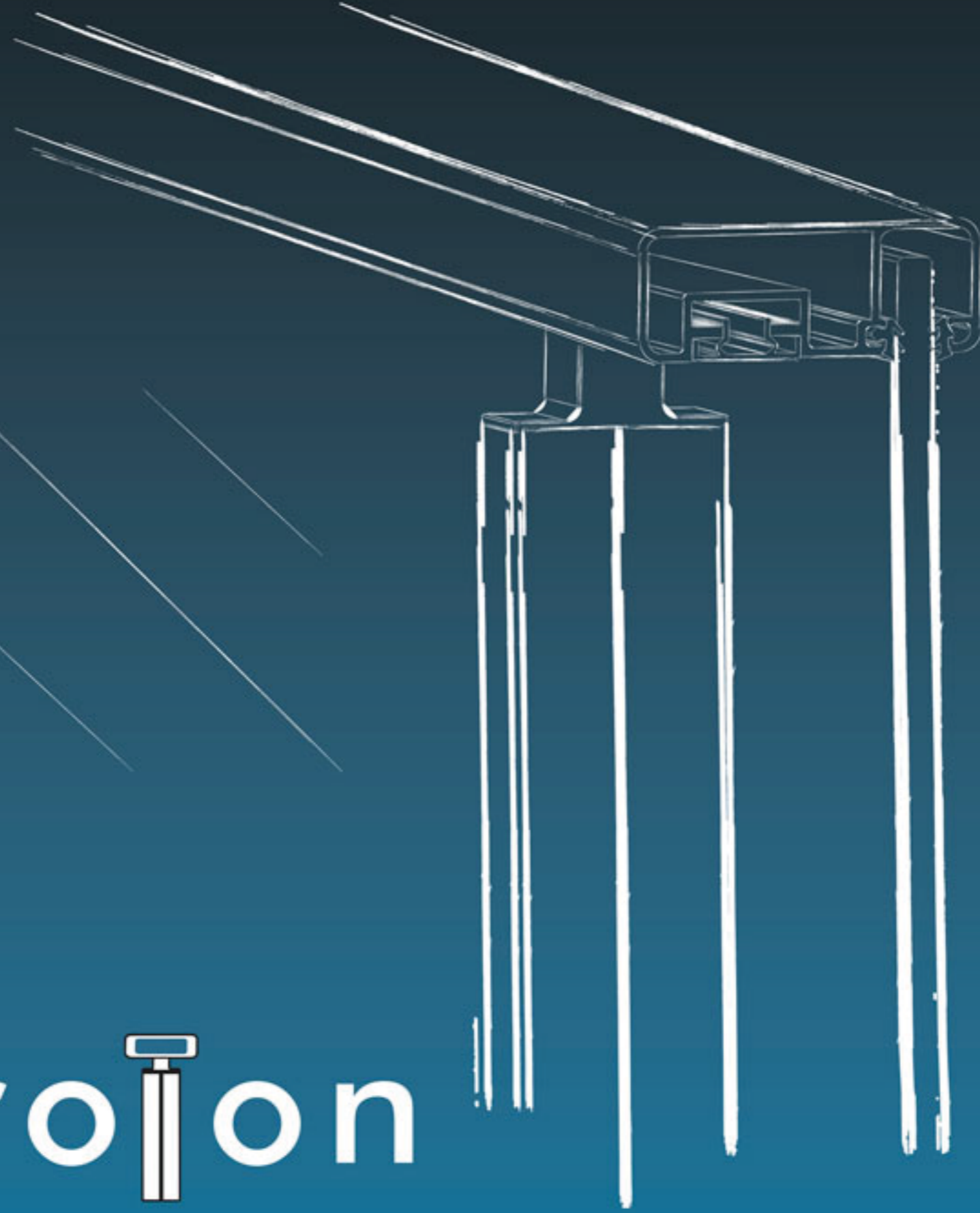

proion

alurail®

KORKULUK SİSTEMLERİ / RAILING SYSTEMS

2014



Quality Certificate



Certificate No. 3670

alurail[®]
KORKULUK SİSTEMLERİ / RAILING SYSTEMS

proion

KÜPEŞTE UYGULAMA ÖRNEKLERİ BALUSTRADE APPLICATION SAMPLES

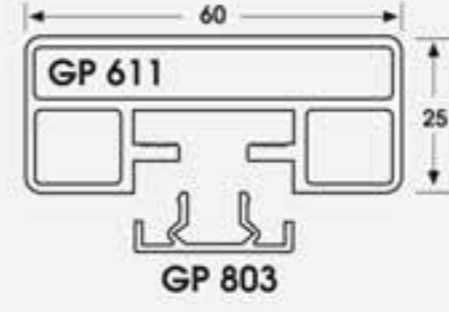
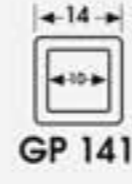
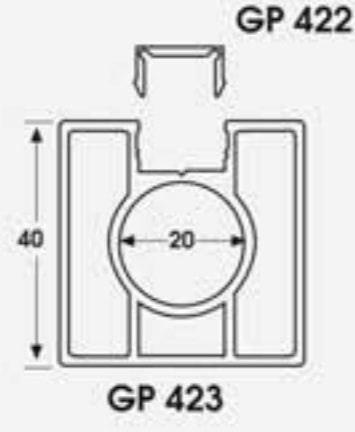
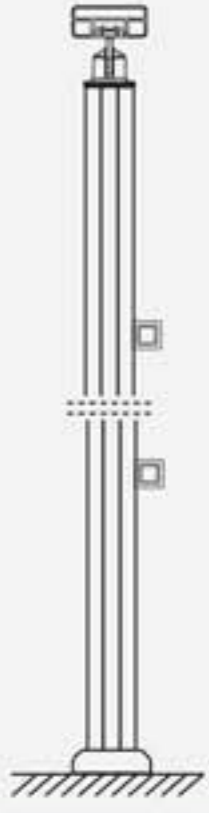

P321-61

alurail
KORKULUK SİSTEMLERİ
RAILING SYSTEMS



GM 421 B



GF 421



GS 614 A



GS 614 B



GS 611 F



GS 143



GS 143 A



GY 404 C



GT 611



GT 141

KÜPEŞTE UYGULAMA ÖRNEKLERİ BALUSTRADE APPLICATION SAMPLES



P224-61

alurail[®]
KORKULUK SİSTEMLERİ
RAILING SYSTEMS



GA 107



GM 521 B



GM 527



GF 751



GF 521



GF 611



GF 611 B



GF 311



GY 611



GY 311



GY 521 A



GT 751



GT 311



GA 751



GA 110

KÜPEŞTE UYGULAMA ÖRNEKLERİ BALUSTRADE APPLICATION SAMPLES

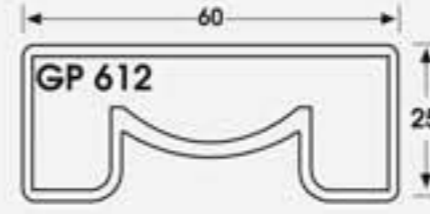
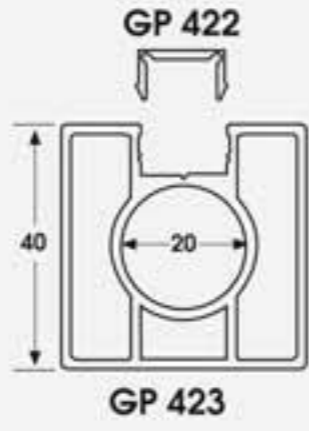

P321-62

alurail[®]
KORKULUK SİSTEMLERİ
RAILING SYSTEMS



GM 421



GM 425 A



GM 102 B



GF 421



GF 611 A



GY 428



GT 611



GT 141



GS 611



GS 614



GS 614 A



GS 141



GS 142 A



GS 143

KÜPEŞTE UYGULAMA ÖRNEKLERİ

BALUSTRADE APPLICATION SAMPLES

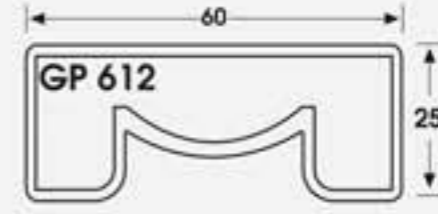
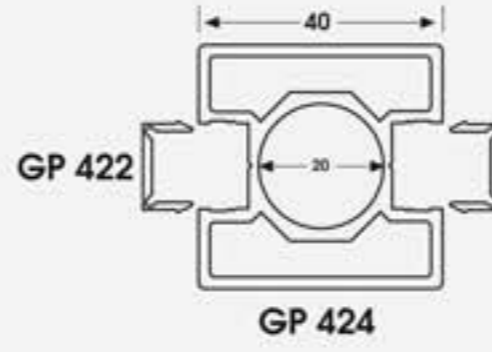
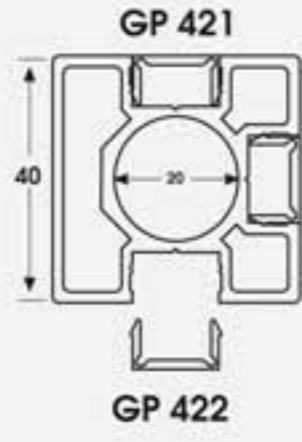

P126-62

alurail[®]
KORKULUK SİSTEMLERİ
RAILING SYSTEMS

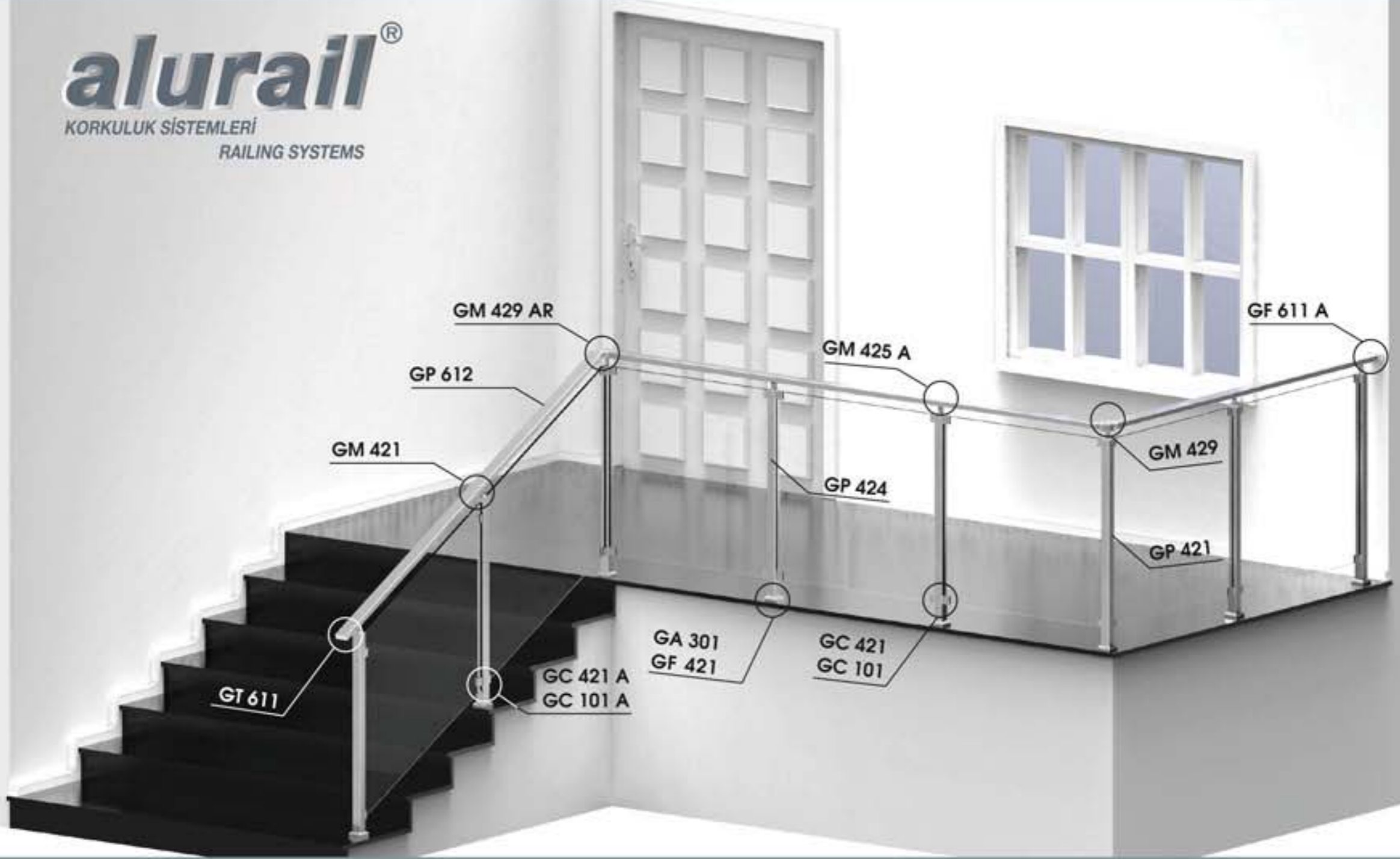

GM 421



GM 425 A



GM 429



GM 429 AR



GF 421



GF 611 A



GT 611



GC 421



GC 421 A



GC 101



GC 101 A

KÜPEŞTE UYGULAMA ÖRNEKLERİ

BALUSTRADE APPLICATION SAMPLES

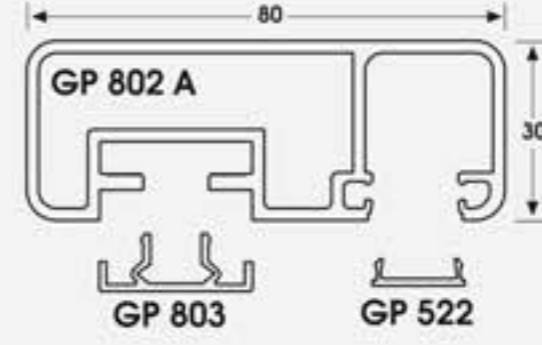
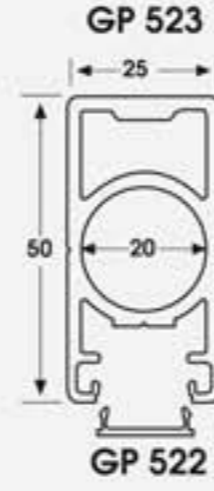
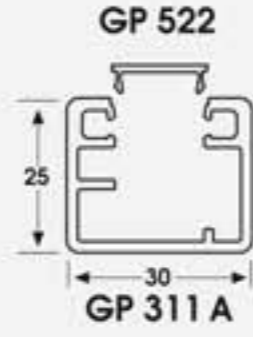

P112-83

alurail[®]
KORKULUK SİSTEMLERİ
RAILING SYSTEMS



GM 527



GF 524



GS 801 A



GS 801 C



GS 311 B1



GS 801 GE



GT 311



GY 313



GY 611



GF 801 CL



GF 801 CR



GV 301 A



GV 301 B

KÜPEŞTE UYGULAMA ÖRNEKLERİ

BALUSTRADE APPLICATION SAMPLES

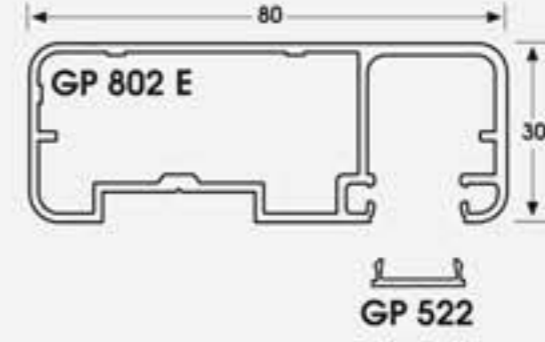
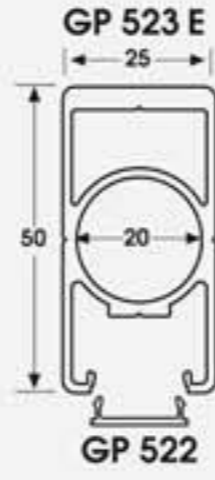
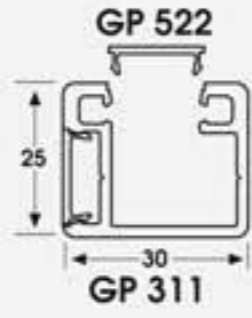

P111-83E

alurail
KORKULUK SİSTEMLERİ
RAILING SYSTEMS

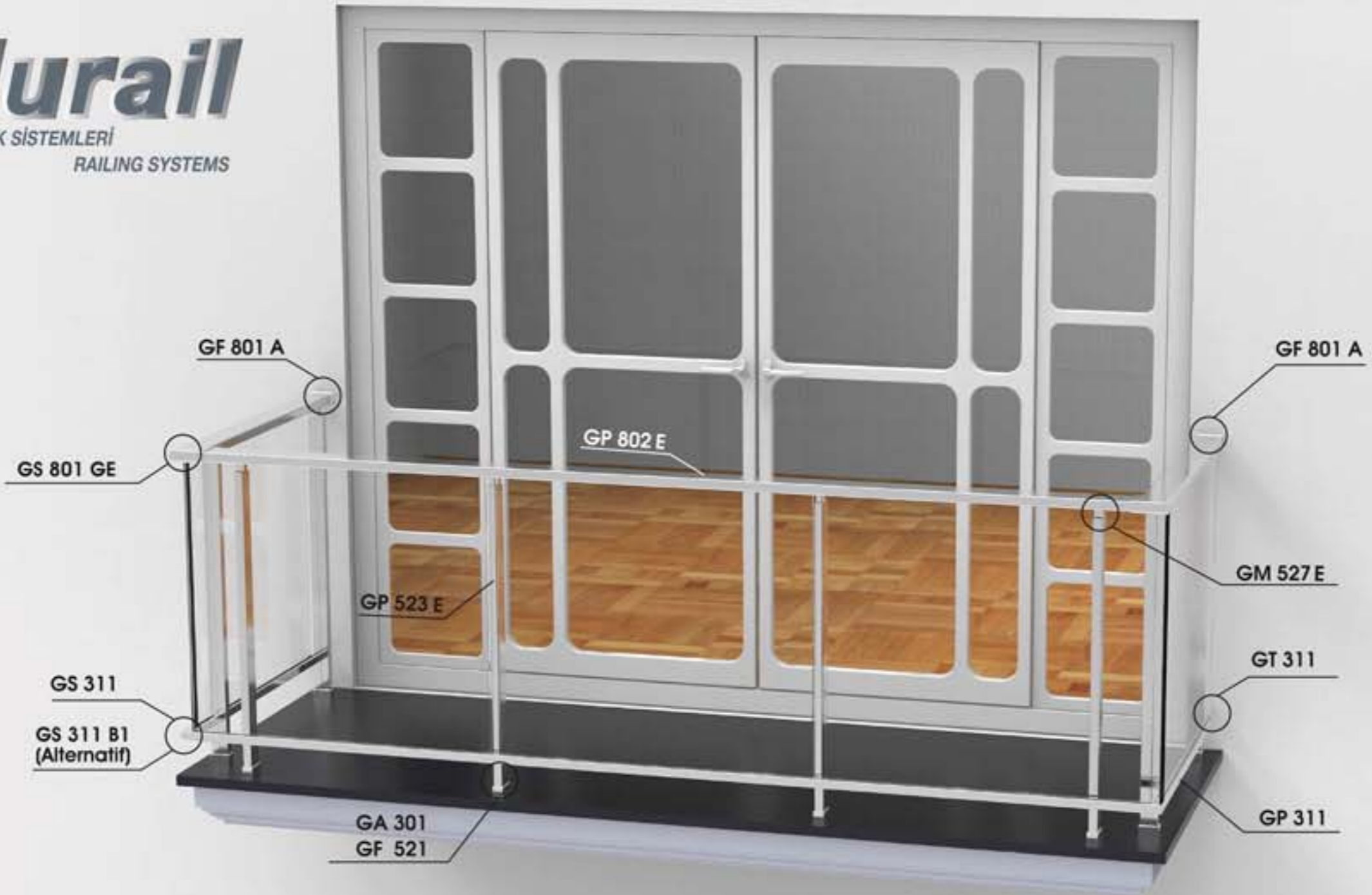

GM 527 E



GF 521



GF 801 A



GT 311



GS 801 GE



GS 311 B1



GS 311



GV 301 A



GV 301 B

KÜPEŞTE UYGULAMA ÖRNEKLERİ

BALUSTRADE APPLICATION SAMPLES

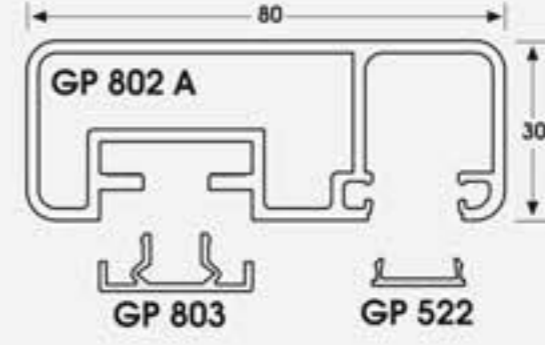
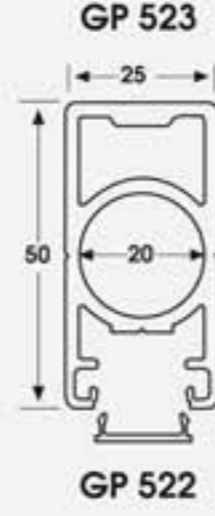
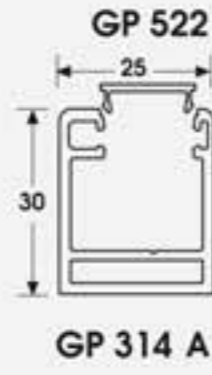
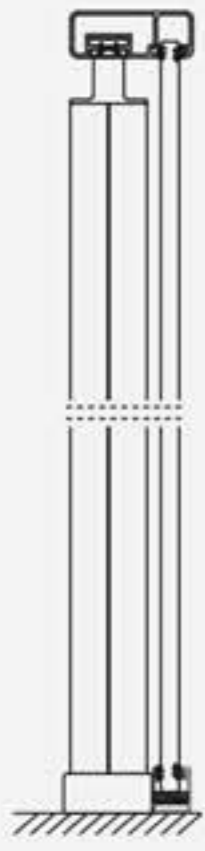

P113-83

alurail[®]
KORKULUK SİSTEMLERİ
RAILING SYSTEMS



GM 527



GF 521



GS 801 A



GS 801 C1



GT 314



GY 611



GF 801 CL



GF 801 CR



GV 301 A



GV 301 B

KÜPEŞTE UYGULAMA ÖRNEKLERİ BALUSTRADE APPLICATION SAMPLES

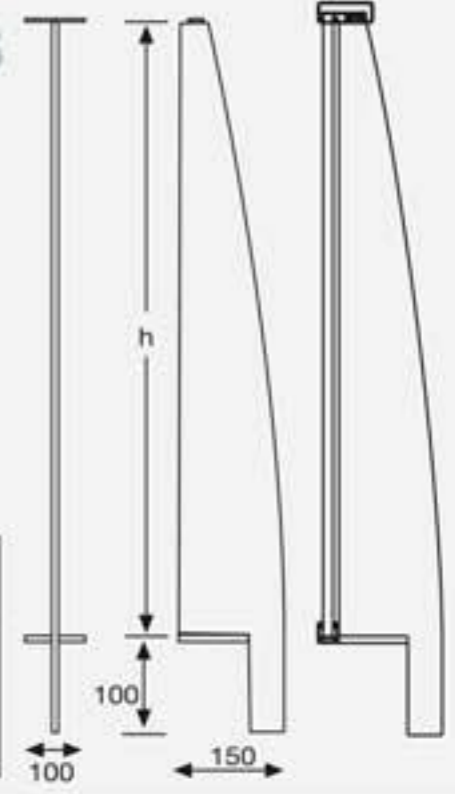
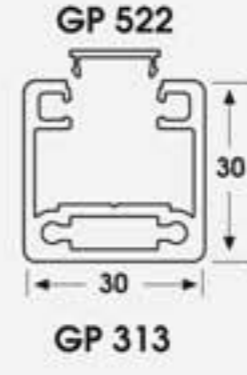
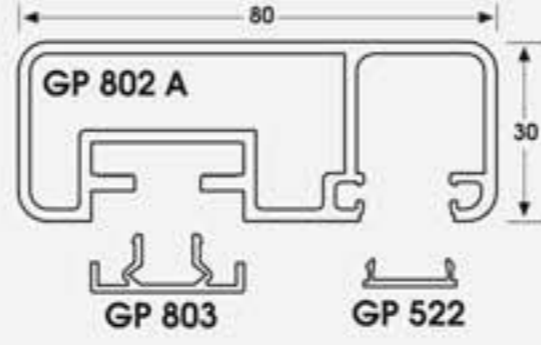
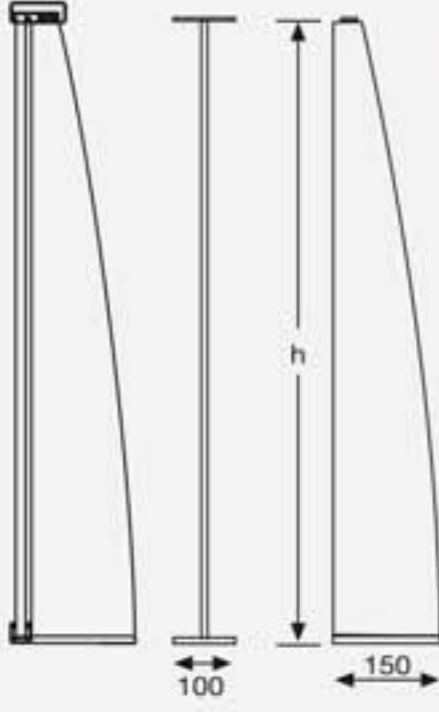

KOD No. ITEM Nr.	h (mm)
GLC 870	870
GLC 970	970

KOD No. ITEM Nr.	h (mm)
GLC 870 L	870
GLC 970 L	970

P113-83L

alurail[®]
KORKULUK SİSTEMLERİ
RAILING SYSTEMS



GS 801 A



GS 801 C



GF 801 CL



GF 801 CR



GY 611



GV 301 A



GV 301 B



GT 313

KÜPEŞTE UYGULAMA ÖRNEKLERİ BALUSTRADE APPLICATION SAMPLES

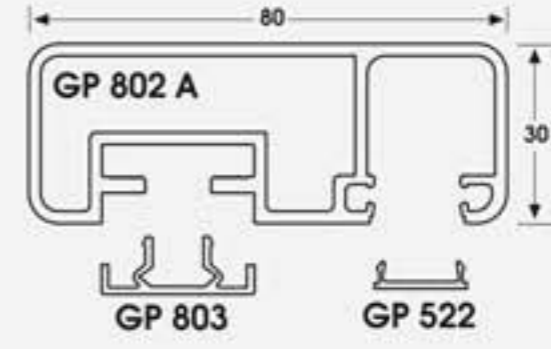
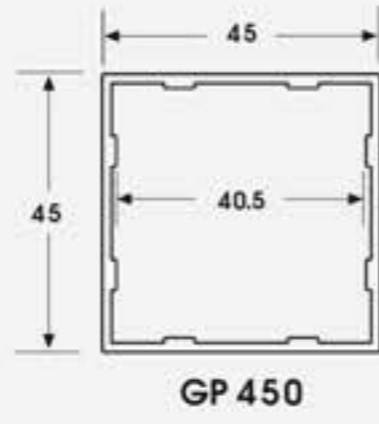
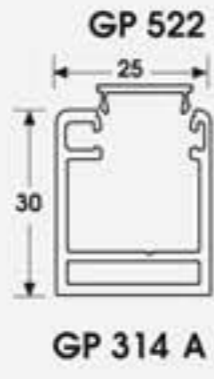

P113-83K

alurail[®]
KORKULUK SİSTEMLERİ
RAILING SYSTEMS

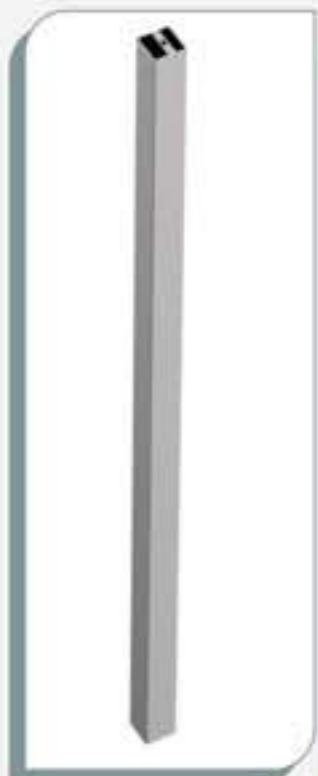

GA 451

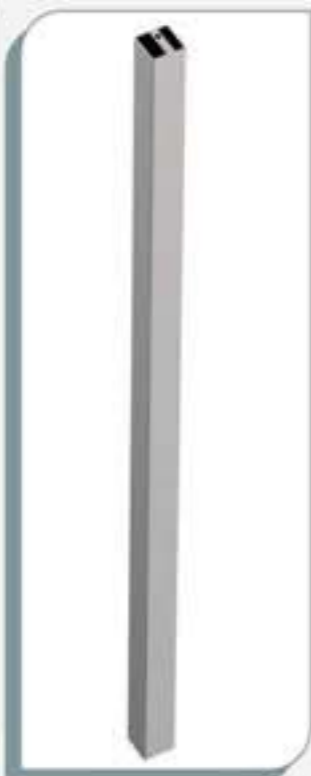

GA 452



GM 457



GM 457 B



GF 451



GF 452



GF 801 A



GS 801 C



GT 314



GV 301 A



GV 301 B

KÜPEŞTE UYGULAMA ÖRNEKLERİ BALUSTRADE APPLICATION SAMPLES

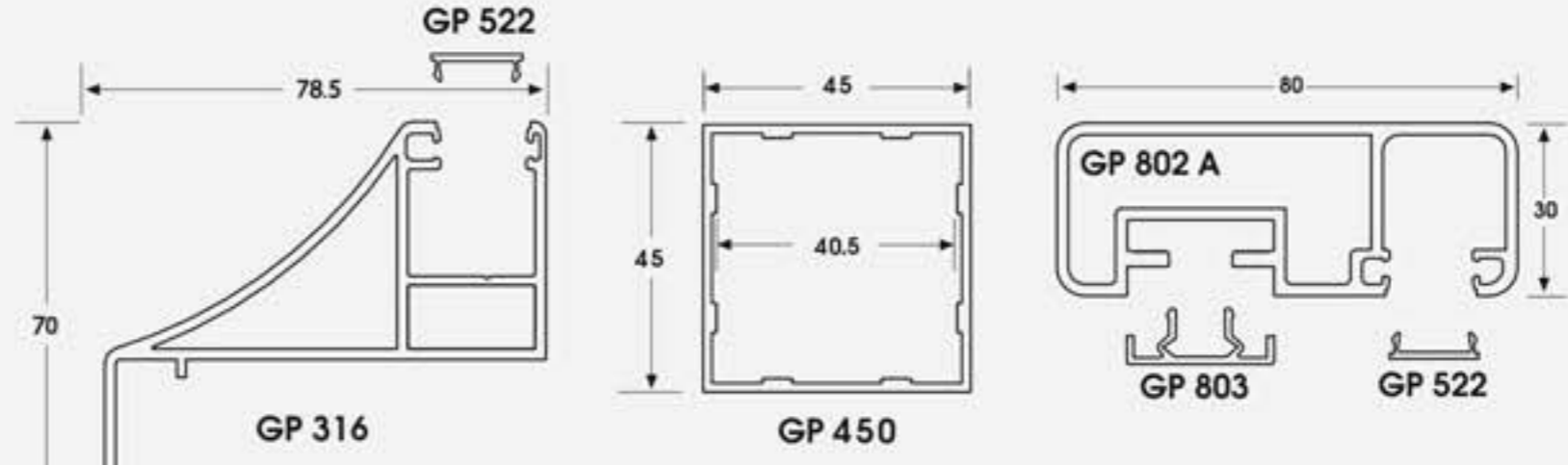

P113-83K

alurail[®]
KORKULUK SİSTEMLERİ
RAILING SYSTEMS

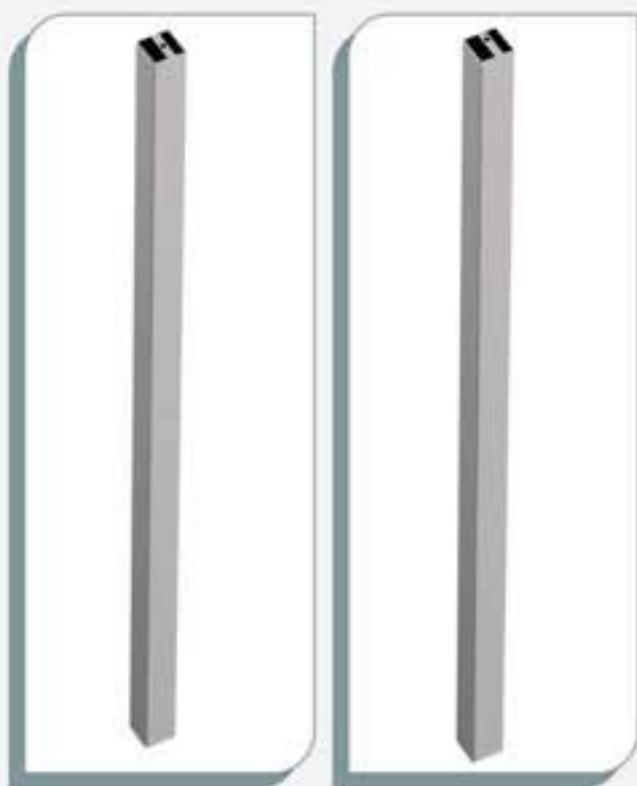

GA 451

GA 452



GM 457



GM 457 B



GF 451



GF 452



GF 801 A



GS 801 C



GV 301 A



GV 301 B

KÜPEŞTE UYGULAMA ÖRNEKLERİ BALUSTRADE APPLICATION SAMPLES

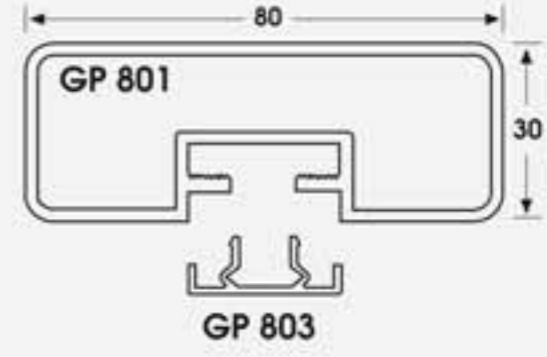
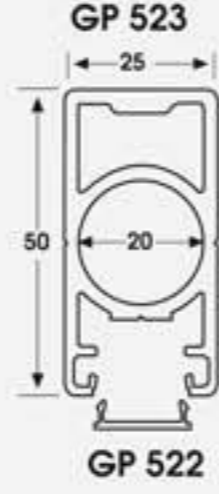
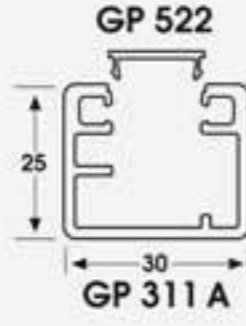
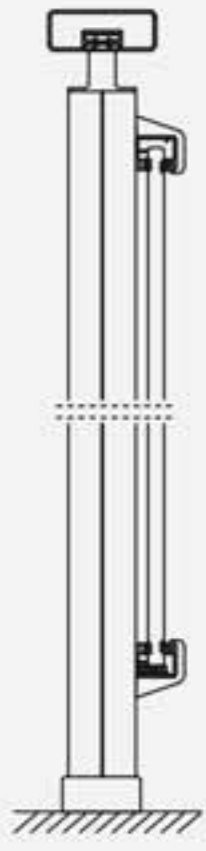

P122-81

alurail[®]
KORKULUK SİSTEMLERİ
RAILING SYSTEMS



GM 527



GF 521



GS 311 B1



GS 801 FE



GT 311



GY 313



GY 611



GF 801 B



GV 301 A



GV 301 B

KÜPEŞTE UYGULAMA ÖRNEKLERİ BALUSTRADE APPLICATION SAMPLES

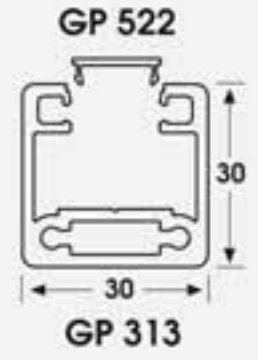
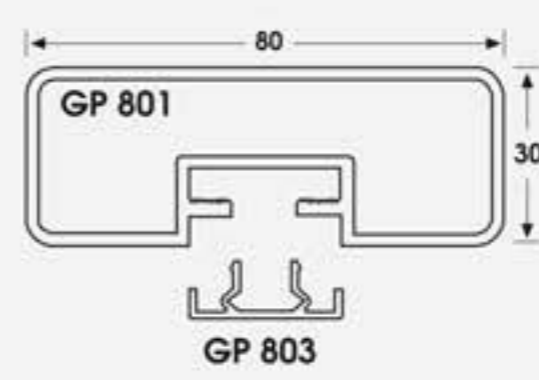
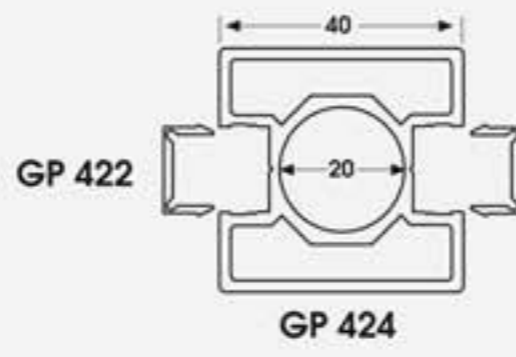
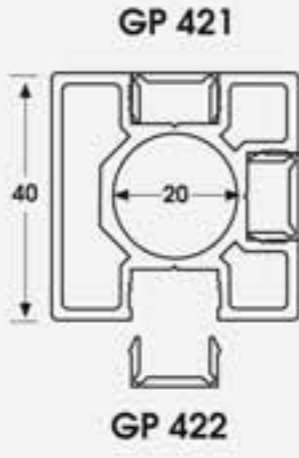

P124-81

alurail[®]
KORKULUK SİSTEMLERİ
RAILING SYSTEMS



GM 427 E



GM 427 F



GS 801 B



GF 421



GF 801 B



GY 611



GY 312



GV 301 A



GV 301 B

KÜPEŞTE UYGULAMA ÖRNEKLERİ BALUSTRADE APPLICATION SAMPLES

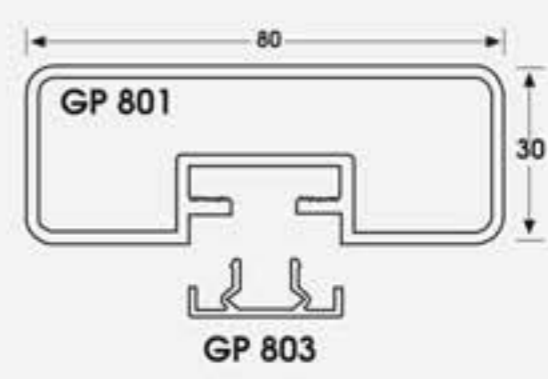
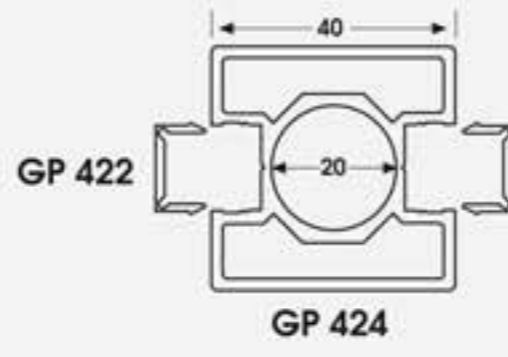
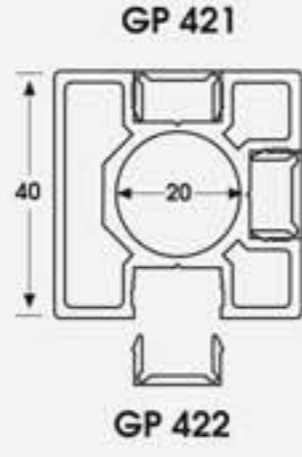

P127-81

alurail[®]
KORKULUK SİSTEMLERİ
RAILING SYSTEMS



GM 427



GM 428



GF 801 A



GF 421



GC 403



GC 404



GC 101

KÜPEŞTE UYGULAMA ÖRNEKLERİ BALUSTRADE APPLICATION SAMPLES

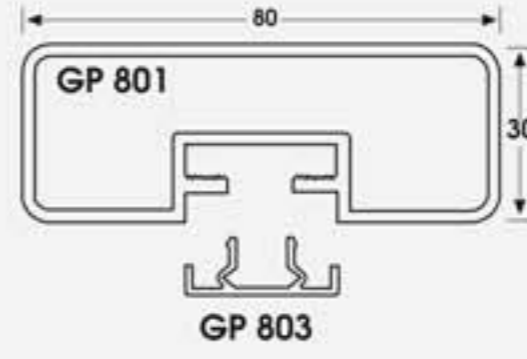
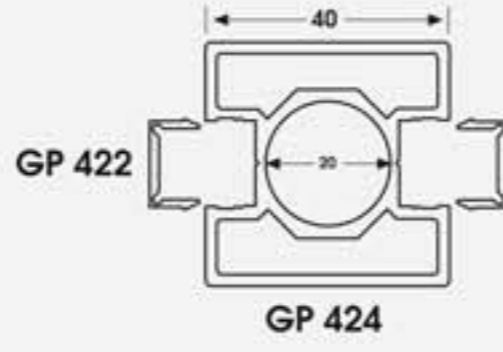
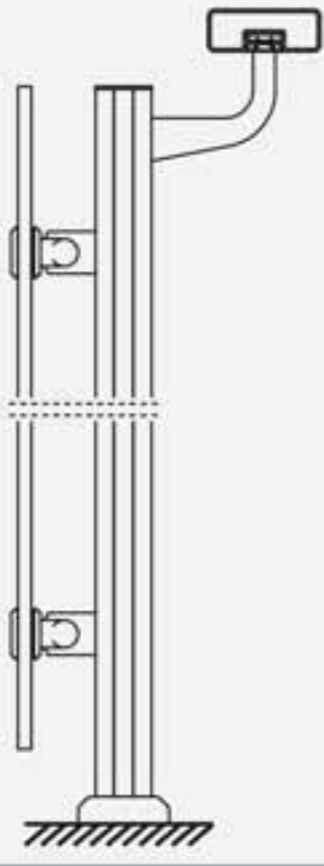

P128-81

alurail[®]
KORKULUK SİSTEMLERİ
RAILING SYSTEMS

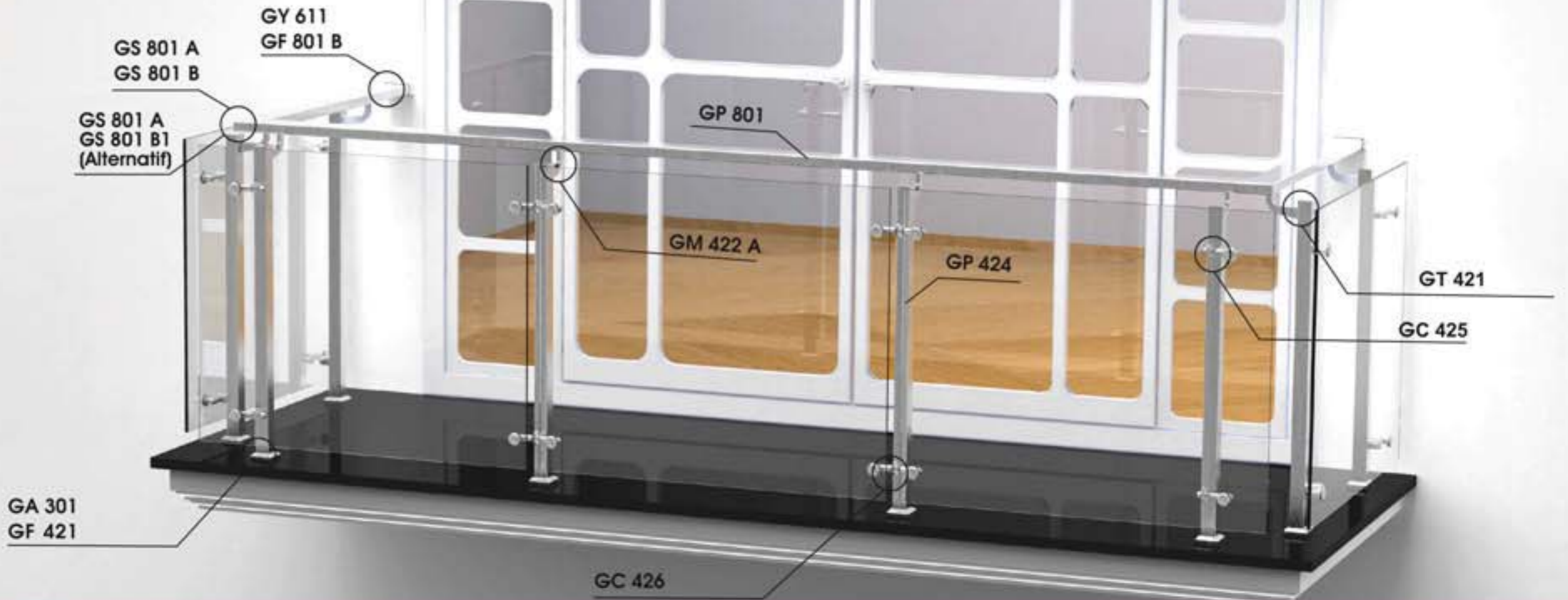

GM 422 A



GS 801 A



GS 801 B



GS 801 B1



GF 421



GF 801 B



GY 611



GC 425



GC 426



GT 421

KÜPEŞTE UYGULAMA ÖRNEKLERİ

BALUSTRADE APPLICATION SAMPLES

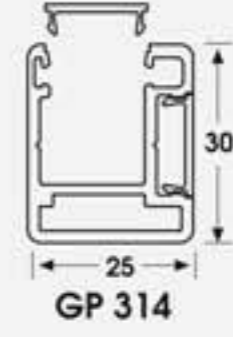
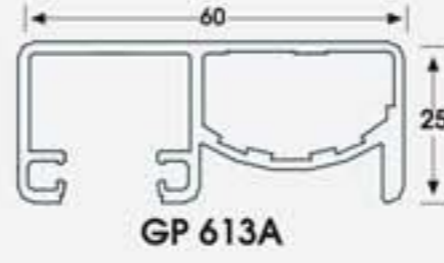
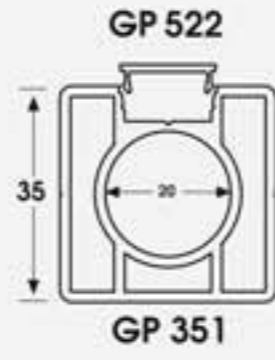

P111-63

alurail[®]
KORKULUK SİSTEMLERİ
RAILING SYSTEMS

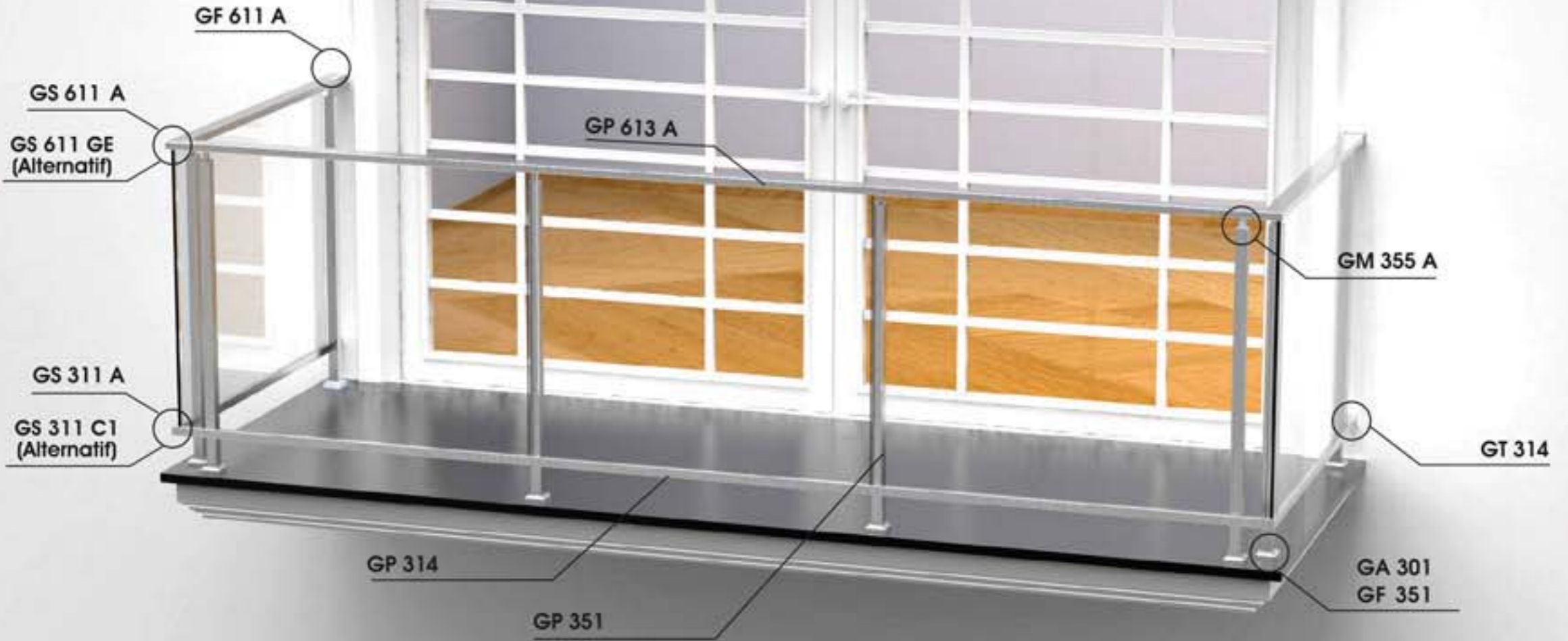

GM 355 A



GF 351



GF 611 A



GS 611 A



GS 311 A



GS 611 GE



GS 311 C1



GT 314



GV 301 A



GV 301 B

KÜPEŞTE UYGULAMA ÖRNEKLERİ BALUSTRADE APPLICATION SAMPLES

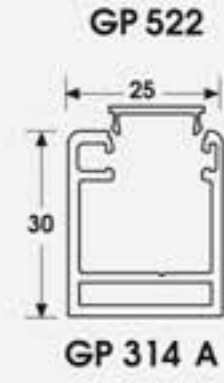
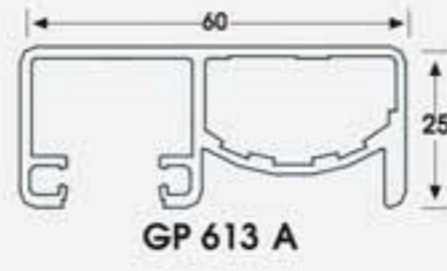

P112-63

alurail[®]
KORKULUK SİSTEMLERİ
RAILING SYSTEMS

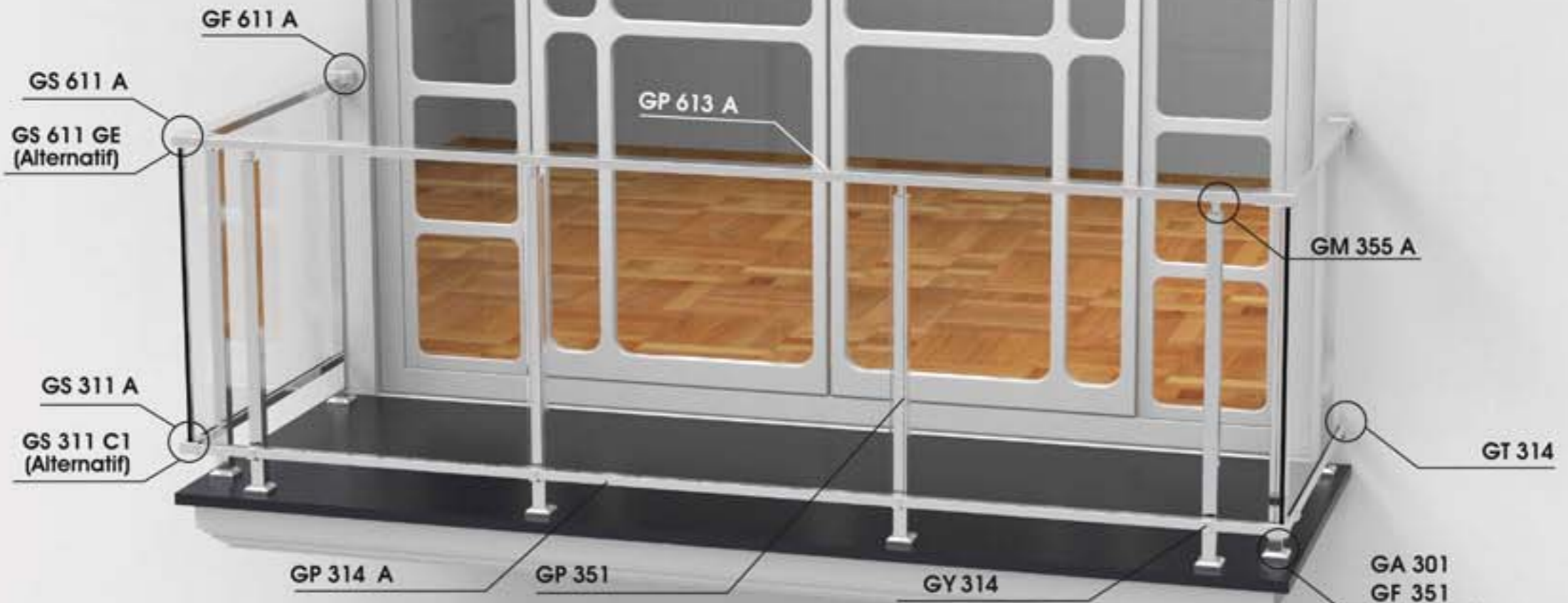

GM 355 A



GF 351



GF 611 A



GS 611 A



GS 311 A



GS 611 GE



GS 311 C1



GT 314



GY 314



GV 301 A



GV 301 B

KÜPEŞTE UYGULAMA ÖRNEKLERİ BALUSTRADE APPLICATION SAMPLES

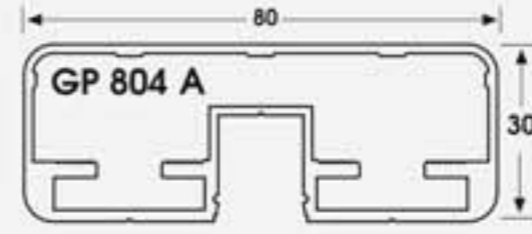
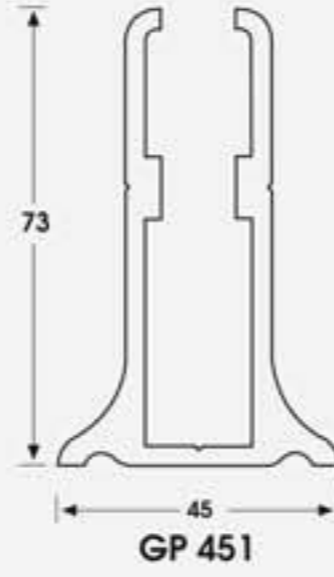

P115-84A

alurail[®]
KORKULUK SİSTEMLERİ
RAILING SYSTEMS



GF 801 D



GS 801



GS 801 E



GS 801 HE



GV 301 D8

KÜPEŞTE UYGULAMA ÖRNEKLERİ BALUSTRADE APPLICATION SAMPLES

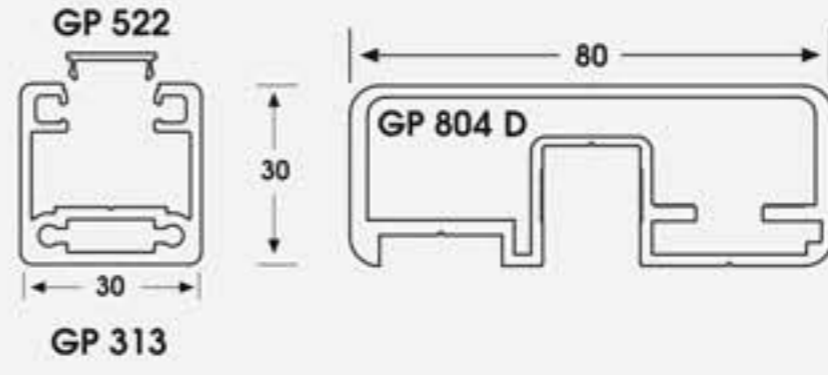

KOD No. ITEM Nr.	h (mm)
GLC 870 A	870
GLC 970 A	970

P113-84D

alurail[®]
KORKULUK SİSTEMLERİ
RAILING SYSTEMS



GF 801 D



GT 313



GS 801 HE



GV 301 D8

KÜPEŞTE UYGULAMA ÖRNEKLERİ BALUSTRADE APPLICATION SAMPLES

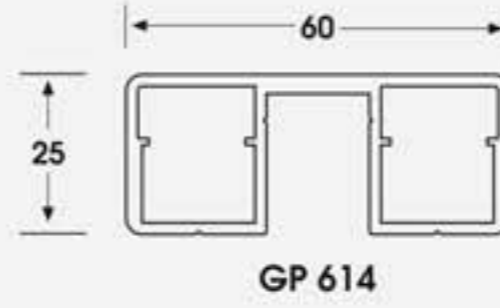
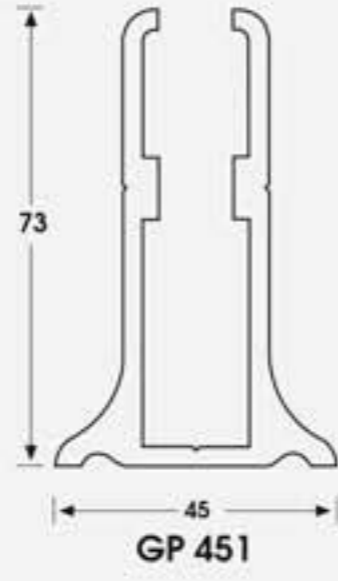

P115-64

alurail[®]
KORKULUK SİSTEMLERİ
RAILING SYSTEMS



GF 611 D



GS 611 HE



GV 301 D8

KÜPEŞTE UYGULAMA ÖRNEKLERİ BALUSTRADE APPLICATION SAMPLES

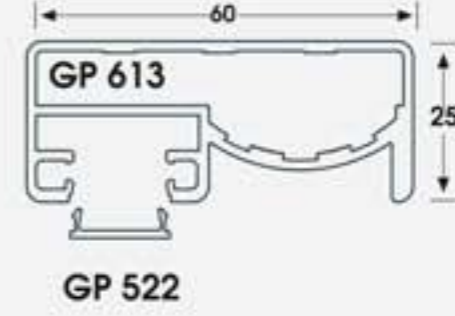
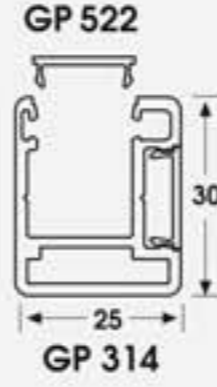
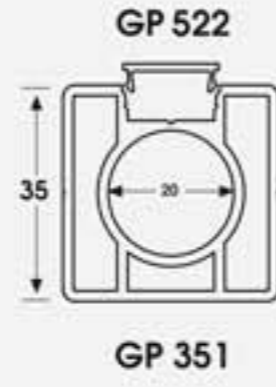

P211-6514

alurail[®]
KORKULUK SİSTEMLERİ
RAILING SYSTEMS



GM 355 A



GF 351



GF 611 A



GS 611 FE



GS 311 C



GT 314

KÜPEŞTE UYGULAMA ÖRNEKLERİ BALUSTRADE APPLICATION SAMPLES

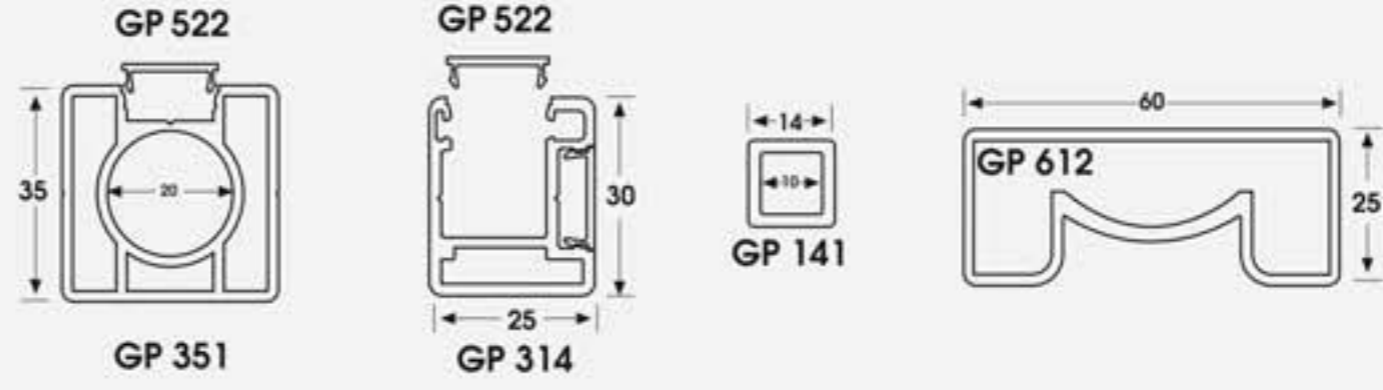

P221-6214

alurail[®]
KORKULUK SİSTEMLERİ
RAILING SYSTEMS

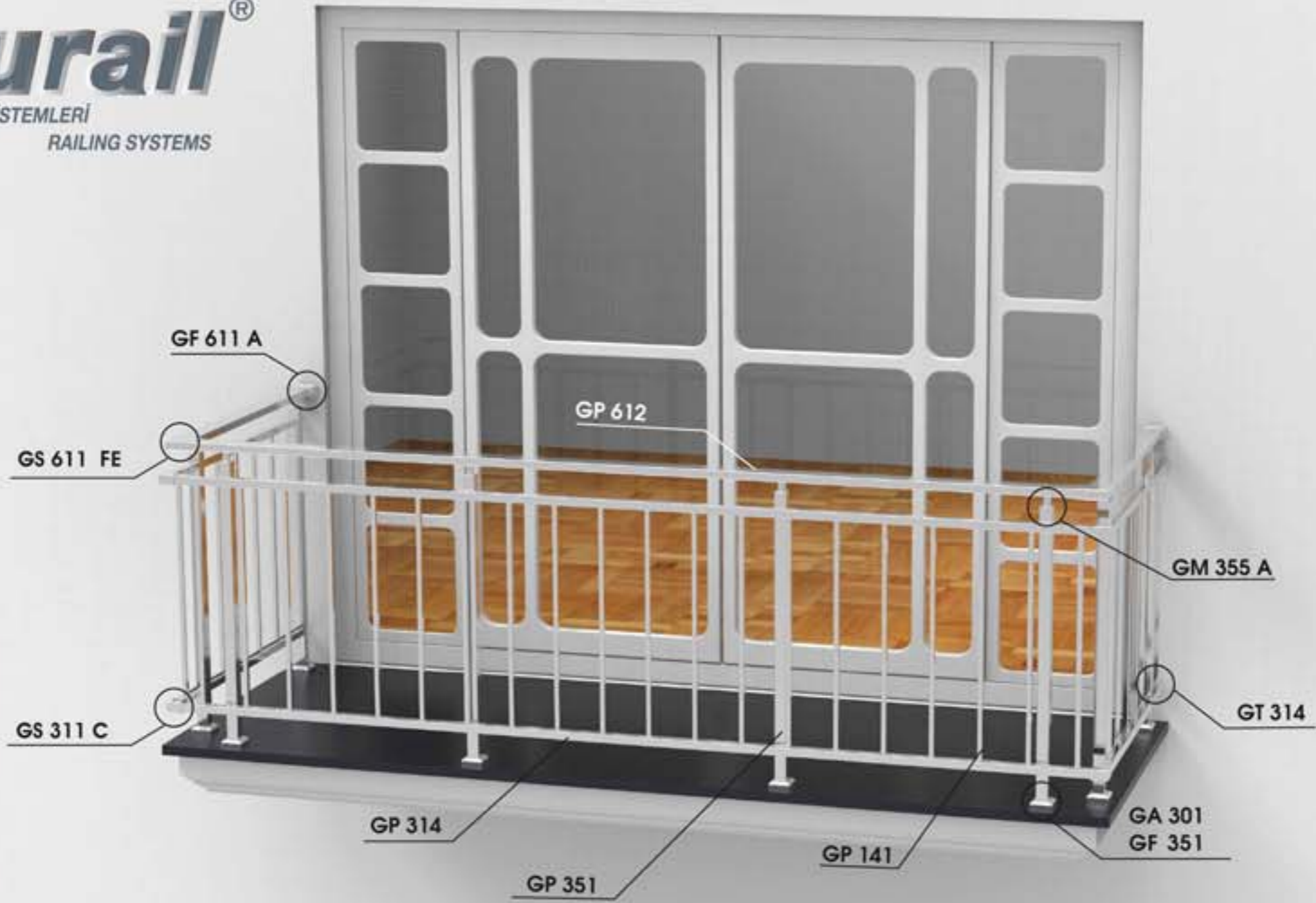

GM 355 A



GF 351



GF 611 A



GS 611 FE



GS 311 C



GT 314

KÜPEŞTE UYGULAMA ÖRNEKLERİ BALUSTRADE APPLICATION SAMPLES

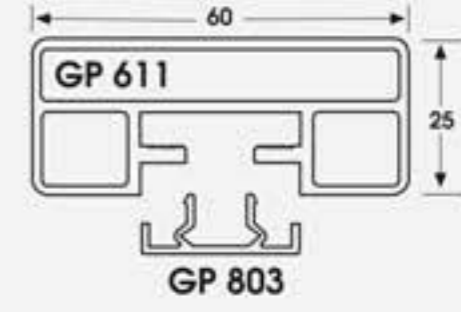
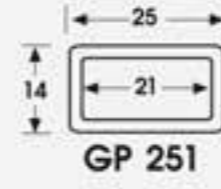
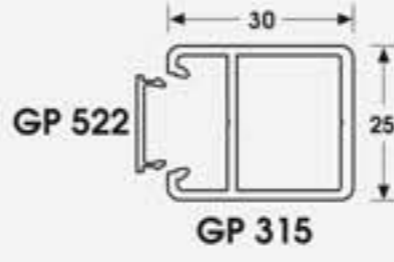
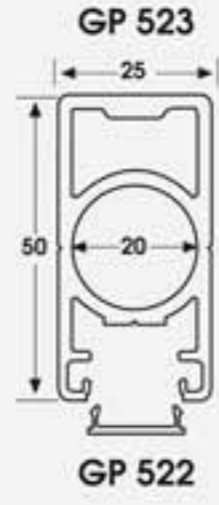

P229-6125

alurail[®]
KORKULUK SİSTEMLERİ
RAILING SYSTEMS

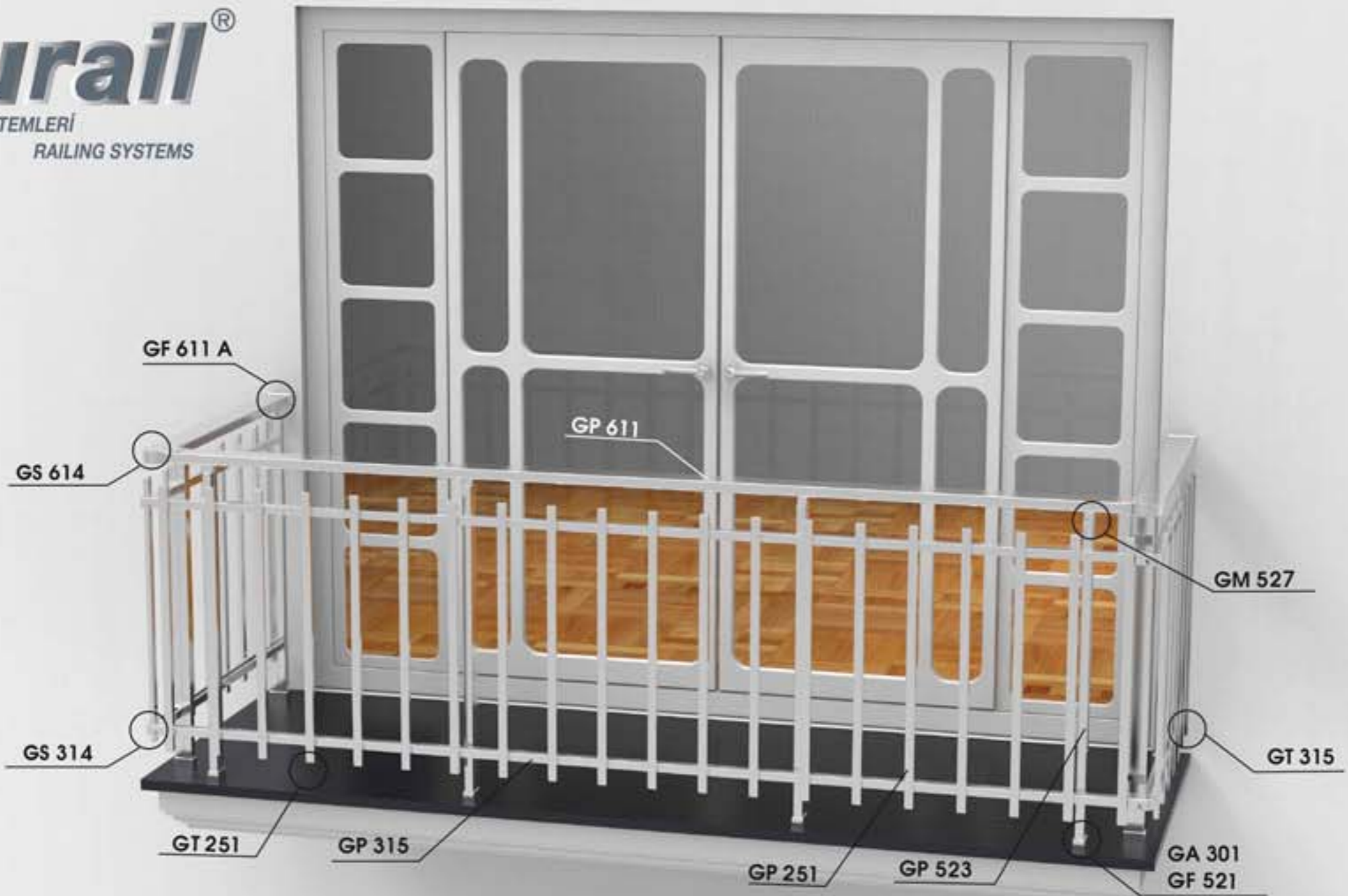

GM 527



GF 521



GF 611 A



GS 614



GS 314



GT 251



GT 315

KÜPEŞTE UYGULAMA ÖRNEKLERİ BALUSTRADE APPLICATION SAMPLES

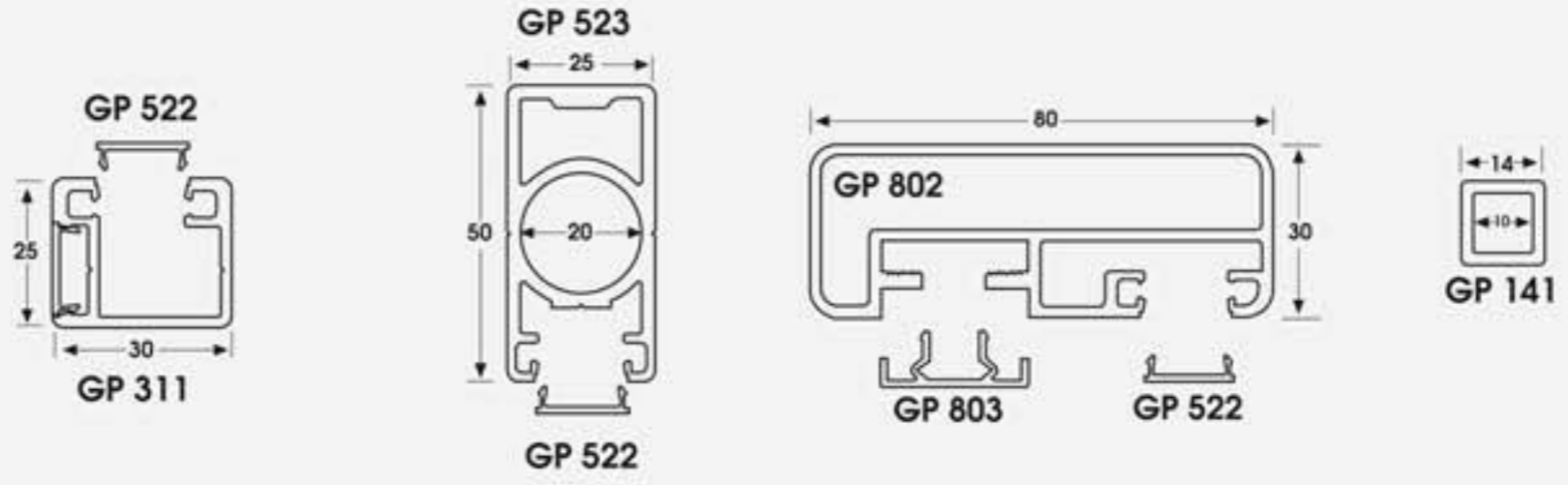

P211-8514

alurail[®]
KORKULUK SİSTEMLERİ
RAILING SYSTEMS



GM 527



GF 521



GS 801 A



GS 801 C



GS 311



GS 801 FE



GS 311 B



GT 311



GY 611



GF 801 B

KÜPEŞTE UYGULAMA ÖRNEKLERİ BALUSTRADE APPLICATION SAMPLES

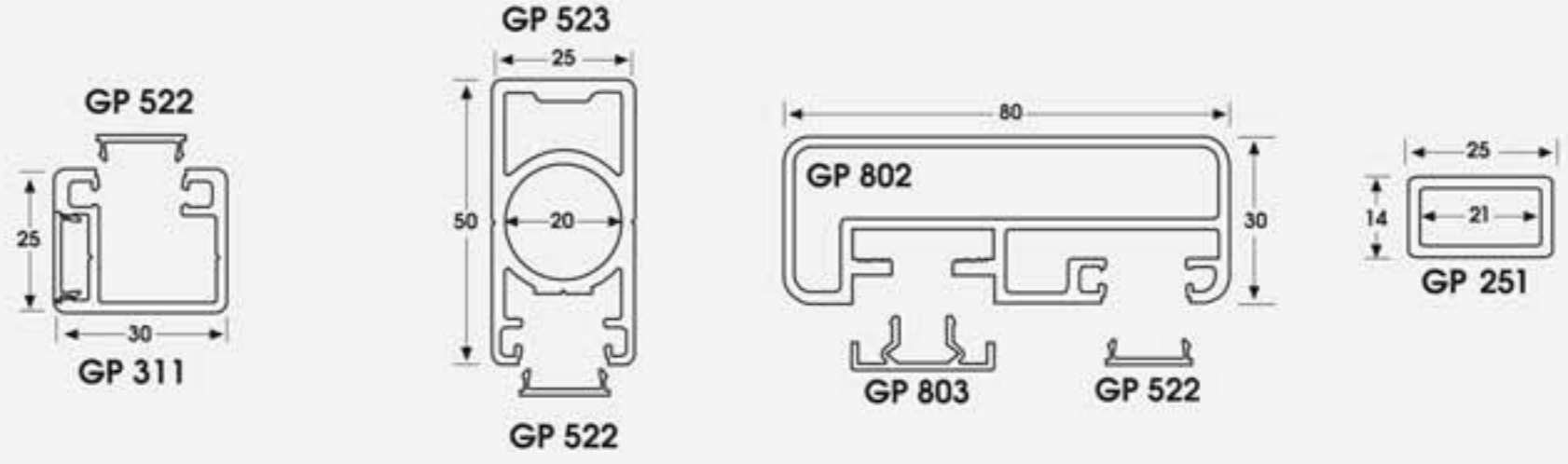

P211-8525

alurail[®]
KORKULUK SİSTEMLERİ
RAILING SYSTEMS



GM 527



GF 521



GS 801 A



GS 801 C



GS 311



GS 801 FE



GS 311 B



GT 311



GY 611



GF 801 B

KÜPEŞTE UYGULAMA ÖRNEKLERİ BALUSTRADE APPLICATION SAMPLES

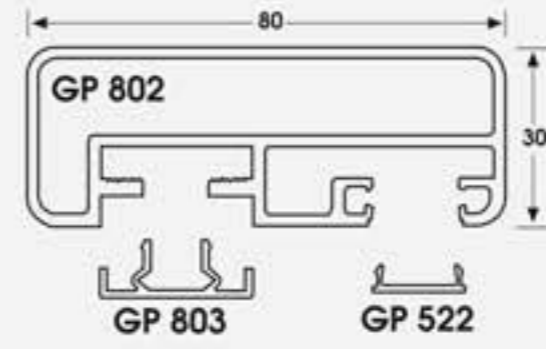
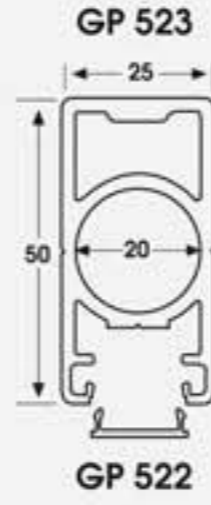
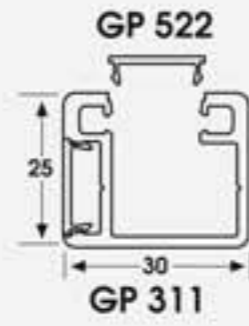

P211-8514C

alurail[®]
KORKULUK SİSTEMLERİ
RAILING SYSTEMS



GM 527



GF 521



GS 801 A



GS 801 C



GS 311



GT 311



GY 611



GF 801 B

KÜPEŞTE UYGULAMA ÖRNEKLERİ BALUSTRADE APPLICATION SAMPLES

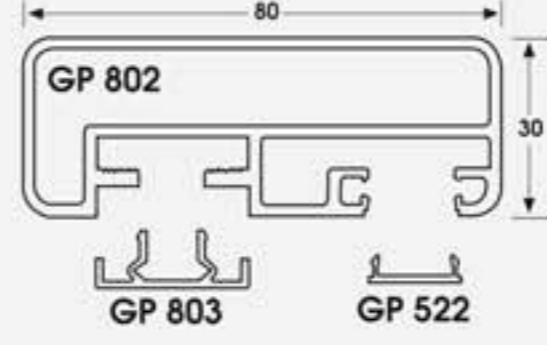
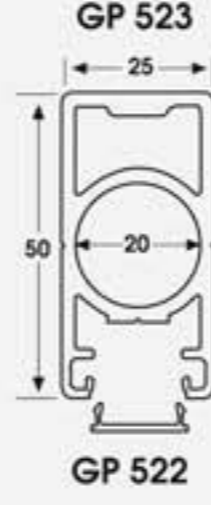
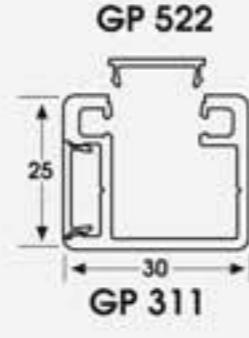

P211-8525C

alurail[®]
KORKULUK SİSTEMLERİ
RAILING SYSTEMS



GM 527



GF 521



GS 801 A



GS 801 C



GS 311



GT 311



GY 611



GF 801 B

KÜPEŞTE UYGULAMA ÖRNEKLERİ BALUSTRADE APPLICATION SAMPLES

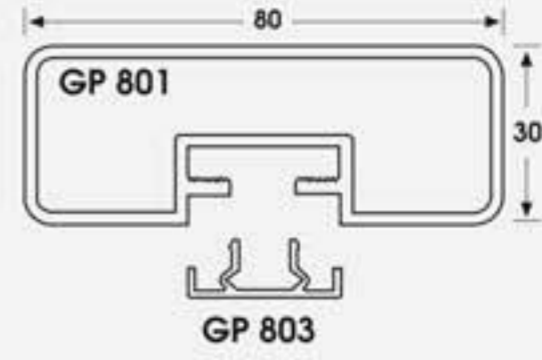
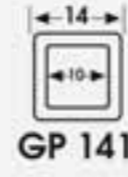
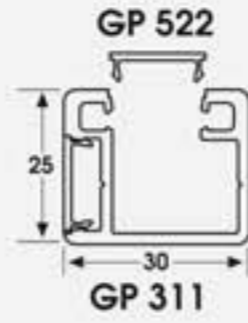
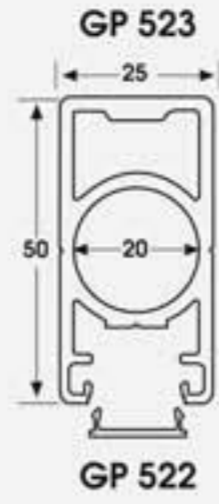

P221-8114

alurail[®]
KORKULUK SİSTEMLERİ
RAILING SYSTEMS

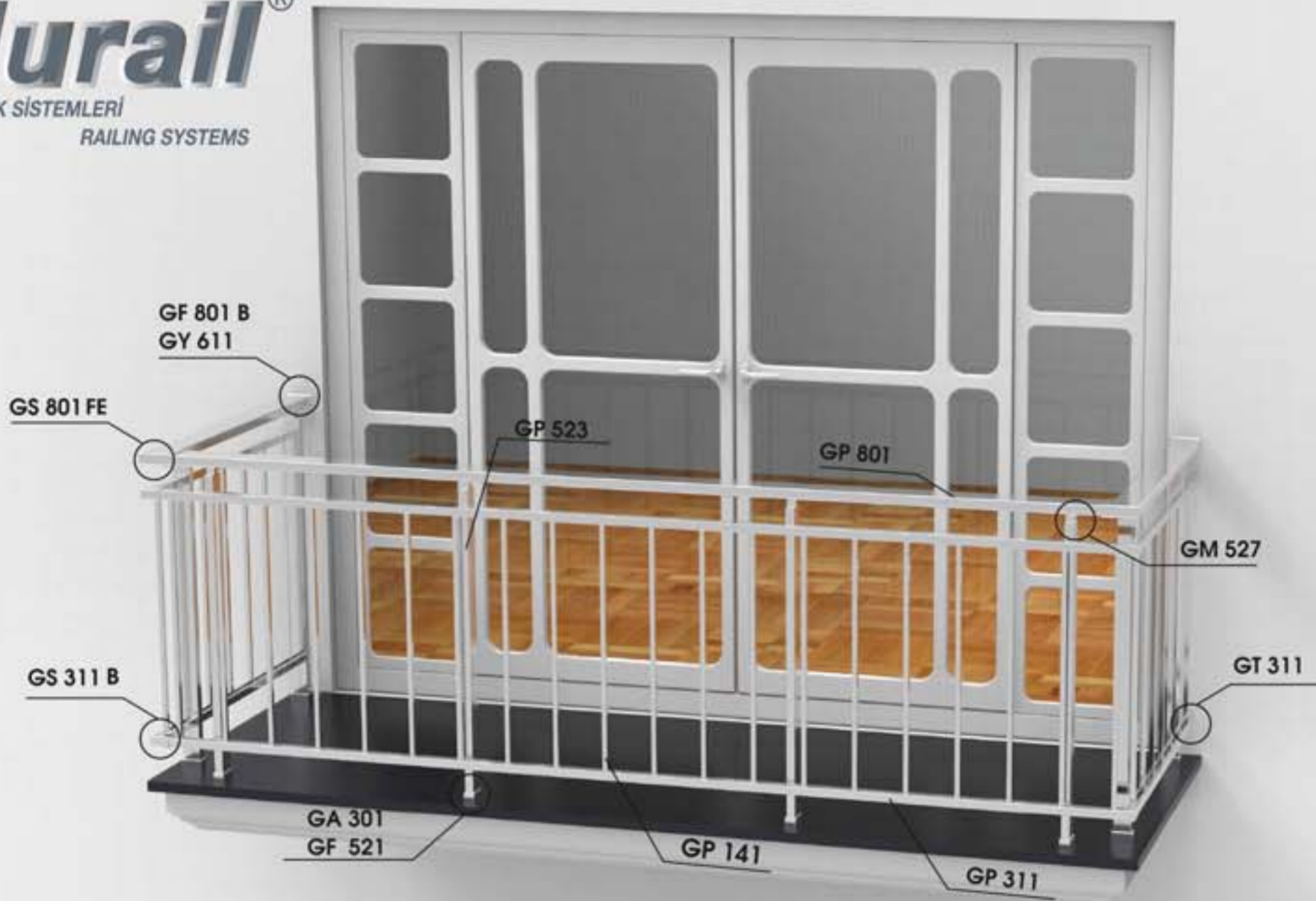

GM 527



GF 521



GS 801 FE



GS 311 B



GT 311



GF 801 A

KÜPEŞTE UYGULAMA ÖRNEKLERİ BALUSTRADE APPLICATION SAMPLES

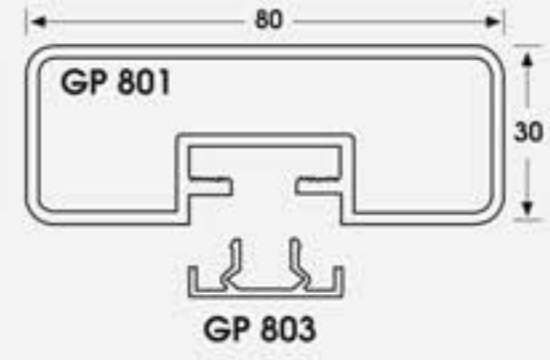
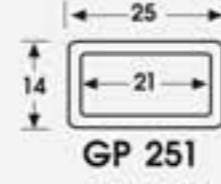
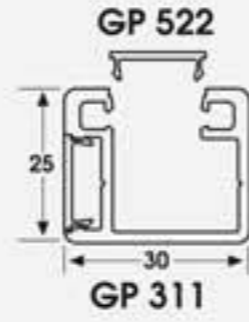
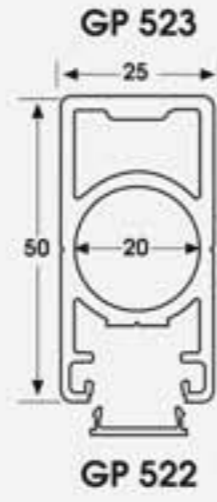

P221-8125

alurail[®]
KORKULUK SİSTEMLERİ
RAILING SYSTEMS



GM 527



GF 523



GS 804



GS 314



GT 311



GF 801 A

alurail®

KORKULUK SİSTEMLERİ / RAILING SYSTEMS

GÜRSAN ALÜMİNYUM tecrübe ve birikimleri ışığında hızla büyüyen **alurail** markası sektörün en modern ve özgün tasarımlarını sizlerle buluşturuyor...

Hızla değişen ve gelişen yapı sektöründe **Yeni Nesil Korkuluk Sistemleri** sloganıyla ürün geliştiren **alurail**, yüksek imalat kabiliyeti ile hızlı bir gelişim göstermiş; dairesel, kare-dikdörtgen ve son olarak da **electron** sistemlerini eksiksiz bir şekilde tasarlayarak yapıların korkuluk sistemlerindeki yeni ve değişen yüzü olmuştur.

electron serisi ile sektöre yeni bir soluk kazandıran **alurail**, bu sisteminin sahip olduğu özgün tasarım, modern çizgi, uygulama kolaylığı, ekonomik yapı gibi özellikleri ile fark yaratmaktadır.

Türkiye'de kendi sektöründe ilk defa bayilik sistemini hayata geçiren, **GÜRSAN** ALÜMİNYUM çatısı altında kurumsallaşma çalışmalarına devam eden **alurail** bu doğrultuda sektördeki tüm gelişmeleri yakından takip etmekte, yurtdışı-yurtiçi distribütörlük ve bayilik bağlantıları kurmakta; fuar, seminer, iş gezileri gibi bir çok etkinlik içerisinde yer almaktadır.

Thanks the experience and knowledge of **GÜRSAN** ALUMINIUM **alurail** the rapidly growing railing brand meets you with the most modern and unique designs of the sector.

alurail is developing products for the rapidly changing construction sector with the slogan "**Next Generation Railing Systems**" **alurail** has completed the programme with the electron system railings after the circular, square and rectangular systems and has become the new face of aluminium railing systems at nowadays structures.

alurail has brought a new breathe to the sector with the unique , modern design and easy installation ability of electron system railings.

GÜRSAN ALUMINIUM is the first in the Turkish Railing Sector, who implements the dealership system under the alurail brand. **GÜRSAN** ALUMINIUM has definitely decided to grow together with alurail dealers and distributors. To support the excellent products, **GÜRSAN** ALUMINIUM takes part in many events such as exhibitions, business trips and seminars.

proion

- Geliştirdiğimiz tüm ürünler tasarım tescil ve faydalı model belgeleri ile koruma altındadır.
- Ürünlerimizden, katalogta bulunan resim ve çizimlerden alıntı yapıldığı takdirde şirketimizce maddi ve manevi tazminat davasına konu edileceğini bilgilerinize sunarız.
- All of the profiles and accessories developed by our company are patented.
- Please note that the pictures and drawings in this catalogue can not be used without our permission.

alurail bir **GÜRSAN** ALÜMİNYUM markasıdır.
alurail is a trademark of **GÜRSAN** ALUMINIUM.

GÜRSAN bildirmeksizin teknik değişiklik yapma hakkını saklı tutar.
GÜRSAN reserves the right to change the specifications without notice.

alurail[®]

KORKULUK SİSTEMLERİ / RAILING SYSTEMS

proilon

 **GÜRSAN**[®]

ALÜMİNYUM İMALAT SANAYİ LTD. ŞTİ.

ALKOP San. Sit. B-7 Blok, No:15 Esenyurt / İstanbul / Türkiye

Tel: +90 212 858 01 61 Faks: +90 212 858 01 65

www.alurail.com.tr facebook.com/alurail

UYGULAMA BAYİ

